

High Performance Pressure Sensor



Features

- ➔ Available with Built in Electronic
- ➔ Large choice of connectors & threads
- ➔ High Performance
- ➔ Extreme accuracy : up to 0,05% FS

Applications

- ➔ Aerospace
- ➔ Energy / Nuclear
- ➔ Railway
- ➔ Navy and shipbuilding applications

The PGP220 series is designed for high accuracy pressure measurements, from -1 up to 600bar and above on request. The sensing element is an advanced piezo-resistive pressure module which together with the latest compensation techniques, provides high performance measurements. It is available with low (millivolt) or high level (Vdc, mA) outputs. In the case of transducers, the built-in electronic ensures a correction of the pressure element while delivering an analogue output. Specified at 1kHz @-3dB (higher on request), signal's bandwidth is not affected by these corrections. Wetted parts being all stainless steel, the sensor is compatible with most media used in Industry, even corrosive ones. High accuracy pressure measurements on test benches is one of the main application for the PGP220 series.

Technical specifications

Pressure ranges (FS)	±1bar ; -1/+2bar ; -1/+3bar ; -1/+5bar ; 3bar ; 5bar ; 10bar ; 20bar ; 40bar ; 100bar ; 250bar ; 400bar ; 600bar ; ±14.5PSI ; -14.5/+30PSI ; -14.5/+40PSI ; -14.5/+70PSI ; 8000PSI ; 40PSI ; 70PSI ; 150PSI ; 300PSI ; 500PSI ; 1500PSI ; 3000PSI ; 5000PSI
Type	Absolute ; Gage
Type (for ranges > 40 bar)	Sealed Gage
Safe overload	150% FS
Burst pressure	300% FS
Power supply	15 to 30Vdc
Consumption	< 10mA
Insulation	> 1000 MOhms under 50Vdc at ambient temperature
Output at -100%FS (only for ± range)	0Vdc
Output at 0%FS (except ranges ±)	0Vdc
Output at 100%FS	10Vdc
Zero and sensitivity settings tolerances	±50mV

Technical Specifications

Non linearity and hysteresis combined	±0.1% FS Option : ±0.05% FS
Non repeatability	±0.02% FS typ.
Signal bandwidth	1000Hz @ -3dB
Compensated temperature range	0 to +60°C Option : -25 to +85°C ; -25 to +125°C (Except M12, 723 Receptacles and PVC Cable)
Operating temperature range	-25 to +125°C (-25 to +90°C with M12, 723 Receptacles and PVC Cable)
Combined thermal zero & sensitivity shifts	±0.01% FS/°C
Constant acceleration in linear vibrations	± 0.02% FS/g (frequency 20-2000Hz, 50g max.)
Mechanical shock	100g ½ sinus 1ms
Electrical protection	Protected against polarity inversion
EMC protection	Compliant to EN61000
Electrical connection	DIN 43650 Receptacle - 4 pins Option : Miniature DIN 43650 mPm Receptacle - 4 pins ; Receptacle M12 - 4 pins ; Hermetic MIL-C-26482 - 6 pins Receptacle ; AWG26, Viton Jacketed Shielded Cable Ø3mm, 4 wires ; AWG24 double Shield PVC Cable, 4 wires ; Hermetic M12 4 pins Receptacle ; Binder 723 Receptacle, 5 pins
Mechanical connection	1/4 Gaz A male ; 1/4 NPT male ; M10x1-4h male with 80° internal cone ; M14x1.5-4h male Option : 1/2 Gaz A male (Gauge) ; 1/4 Gaz female ; 7/16-20 UNJF-3A male - MS33656-4 ; M10x1-4h male 120° cone
Material(s) of wetted parts	Stainless Steel 316L ; Stainless Steel 17-4PH ; Stainless steel 15-5PH
Weight	< 120g without cable
Enclosure protection	IP65 for absolute & sealed gage version

Codification

High Performance Pressure Sensor	PGP22	6	S	20bar	A	01	01	A	2	2
Output Signal										
	0-10Vdc	6								
Material										
	Stainless Steels		S							
Range										
	Example			20bar						
Type										
	Absolute				A					
	Gage				G					
	Sealed Gage				SG					
Mechanical connection										
	M14x1.5-4h male					01				
	1/2 Gaz A male (Gauge)					06				
	1/4 Gaz A male					07				
	1/4 Gaz female					08				
	7/16-20 UNJF-3A male - MS33656-4					10				
	1/4 NPT male					13				
	M10x1-4h male with 80° internal cone					19				
	M10x1-4h male 120° cone					21				
Electrical connection										
	DIN 43650 Receptacle - 4 pins						01			
	Miniature DIN 43650 mPm Receptacle - 4 pins						02			
	Hermetic MIL-C-26482 - 6 pins Receptacle						03			
	Receptacle M12 - 4 pins						07			
	AWG26, Viton Jacketed Shielded Cable Ø3mm, 4 wires						08/1m			
	AWG24 double Shield PVC Cable, 4 wires						10/1m			
	Hermetic M12 4 pins Receptacle						15			
	Binder 723 Receptacle, 5 pins						23			
Compensated temperature range										
	0 to +60°C							A		
	-25 to +85°C							B		
	-25 to +125°C (Except M12, 723 Receptacles and PVC Cable)							C		
Non linearity and hysteresis combined										
	±0.1% FS								2	
	±0.05% FS								4	
Combined thermal zero & sensitivity shifts										
	±0.01% FS/°C									2

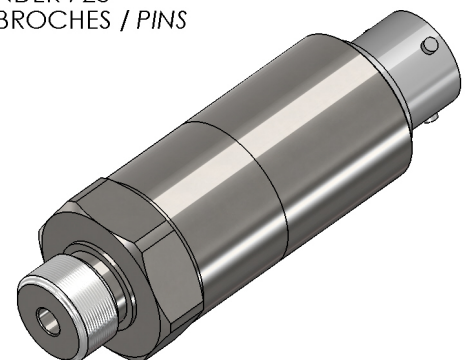
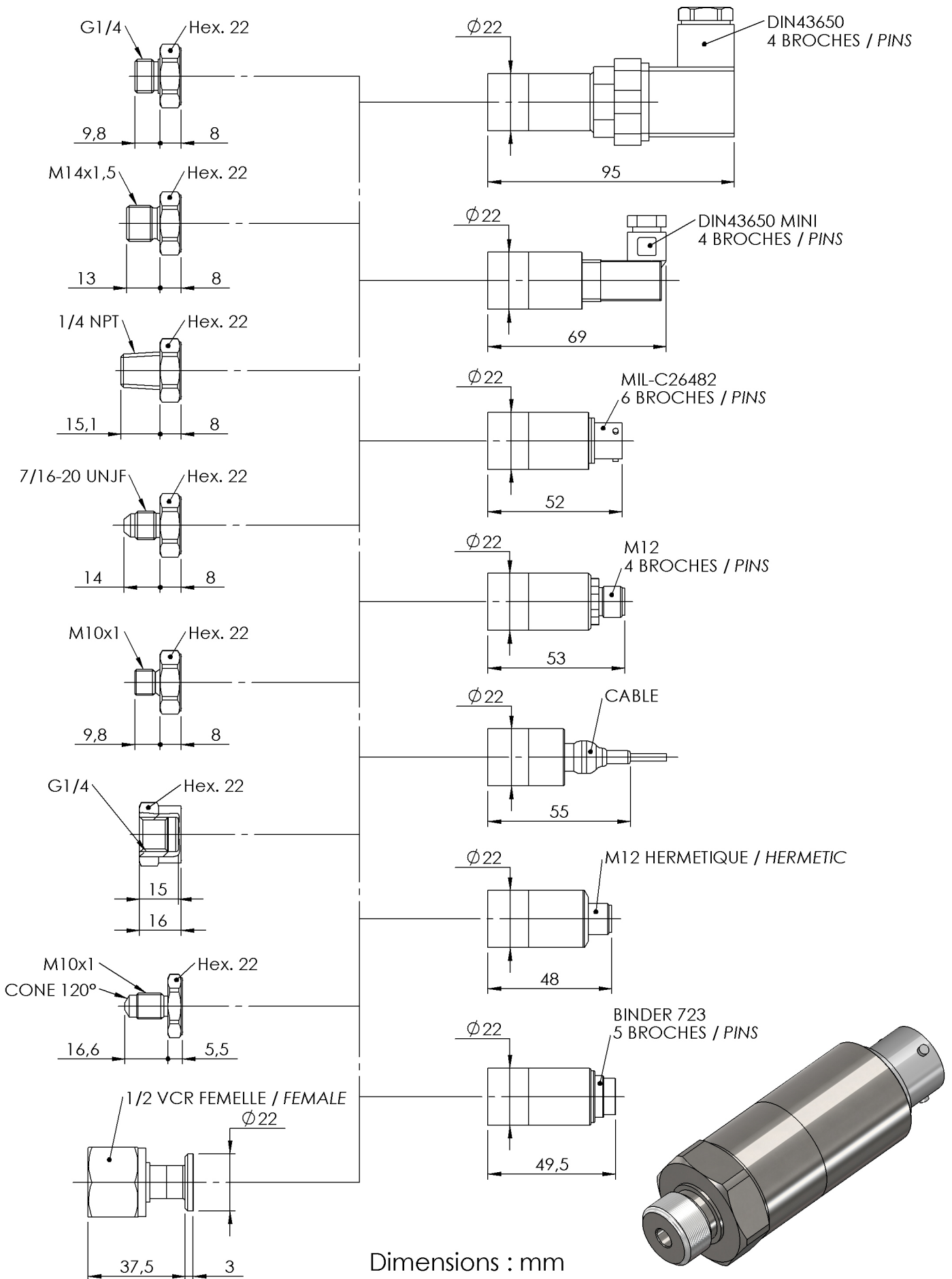

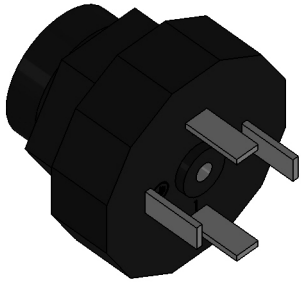

DIN 43650 - 4 PINS

VOLTAGE OUTPUT	PIN
+ EXCITATION	PIN 1
+ SIGNAL	PIN 2
0 VOLT	PIN 3
SENSOR HOUSING	PIN T

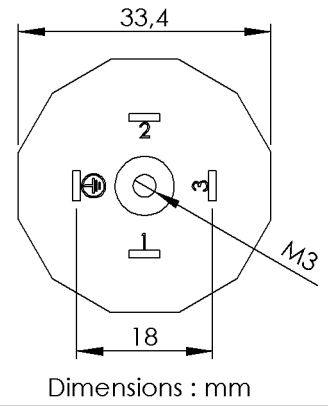

MIL-C26482 - 6 PINS

VOLTAGE OUTPUT	PIN
+ EXCITATION	PIN A
+ SIGNAL	PIN B
0 VOLT	PIN C
0 VOLT	PIN D
SENSOR HOUSING	PINS E & F

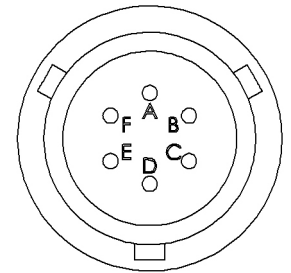

#26 AWG, 4 CONDUCTOR SHIELDED VITON CABLE

VOLTAGE OUTPUT	CONDUCTOR
+ EXCITATION	RED
+ SIGNAL	GREEN / YELLOW
NC	WHITE
0 VOLT	BLUE / BLACK
SENSOR HOUSING	SHIELD

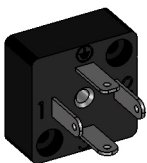
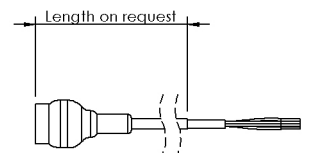

DIN MINIATURE 43650 - 4 PINS

VOLTAGE OUTPUT	PIN
+ EXCITATION	PIN 1
+ SIGNAL	PIN 2
0 VOLT	PIN 3
SENSOR HOUSING	PIN T

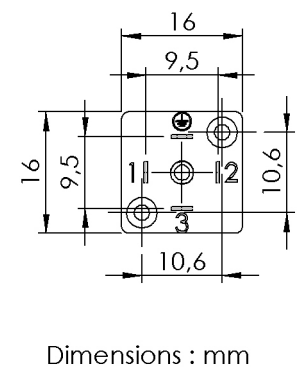

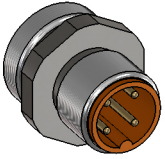

M12 - 4 PINS	
VOLTAGE OUTPUT	PIN
+ EXCITATION	PIN 1
+ SIGNAL	PIN 4
NC	PIN 2
0 VOLT	PIN 3
SENSOR HOUSING	CONNECTOR HOUSING

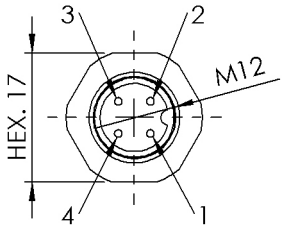

Dimensions : mm

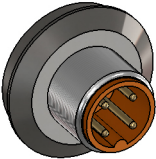

HERMETIC M12 - 4 PINS	
VOLTAGE OUTPUT	PIN
+ EXCITATION	PIN 1
+ SIGNAL	PIN 4
NC	PIN 2
0 VOLT	PIN 3
SENSOR HOUSING	CONNECTOR HOUSING

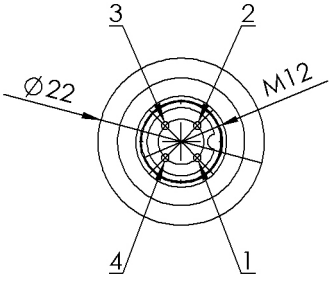

Dimensions : mm

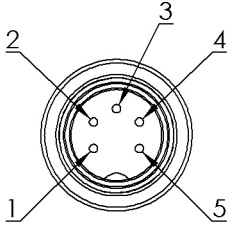
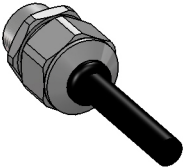

BINDER 723 - 5 PINS	
VOLTAGE OUTPUT	PIN
+ EXCITATION	PIN 3
+ SIGNAL	PIN 2
NC	PIN 4
0 VOLT	PIN 1
NC	PIN 5
SENSOR HOUSING	CONNECTOR HOUSING

#24 AWG, 4 CONDUCTOR, DOUBLE SHIELD PVC CABLE	
VOLTAGE OUTPUT	CONDUCTOR
+ EXCITATION	RED
+ SIGNAL	GREEN
0 VOLT	WHITE
NC	BLACK
SENSOR HOUSING	SHIELD

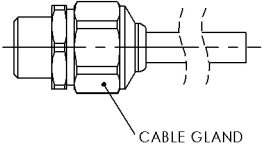

CABLE GLAND



E.F.E.

L'ESSOR FRANCAIS ELECTRONIQUE

16 Rue Porte a Bateaux - 27540 Ivry-la-Bataille - FRANCE

Tel : 33 (0)2 32 22 35 05 - Fax : 33 (0)2 32 36 93 08

www.efe-sensor.com - infos@efe-sensor.com

Agent :